

Extempore

© design by Arnold Merckx

Chairs
Tables
Benches
Tables extra high
Bench extra high

Floor fastening
Cushions



Chair

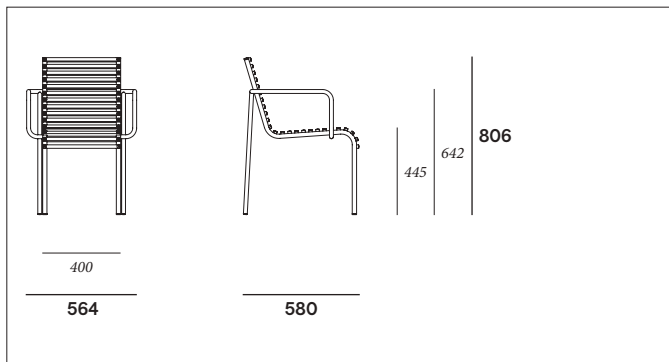

Low chair high back

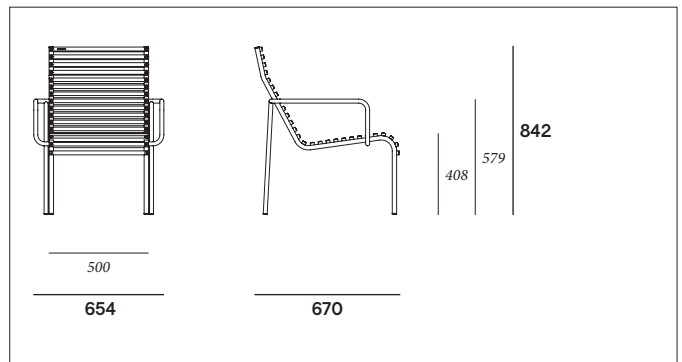

Lounge chair

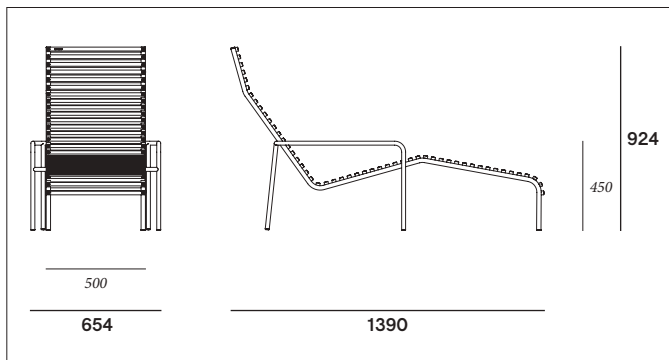

Footrest

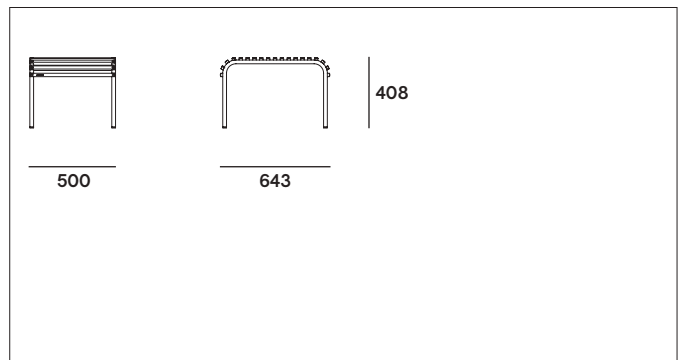

Sunbed

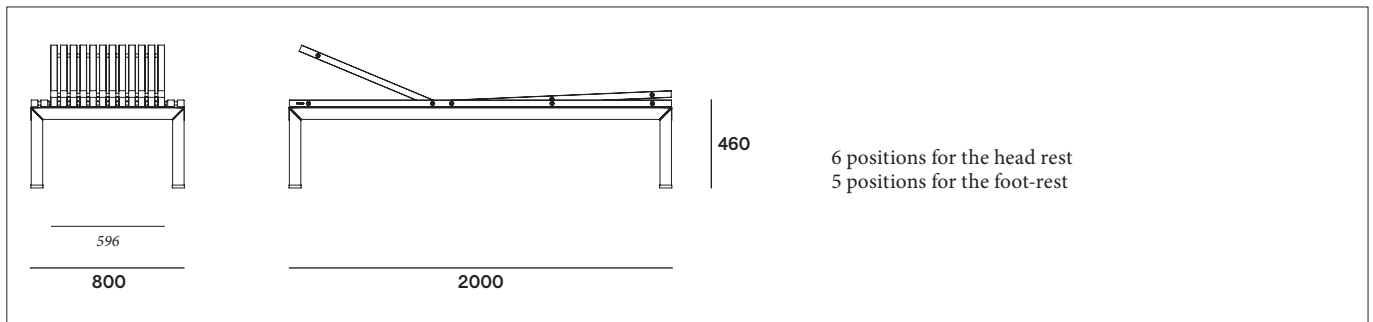

extremis®

The content of this document, in particular the mentioned models, is protected by copyrights and/or design rights. The present document and its content is communicated to you for information purposes only. Any partial or total reproduction or any other use without our prior written permission is strictly prohibited. This technical sheet remains subject to possible changes. **All dimensions are in mm**, unless mentioned otherwise. Extremis is not responsible for the errors in the documentation of products. All measurements are approximate and are provided for informational purposes only.

Tech sheet
20190208

BOX 1: CHAIR

Maximum 4 chairs per box
 Gross weight (kg): 24,71 | Net weight (kg): 19,56

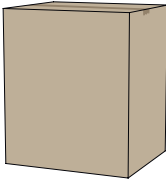
**BOX 2: LOW CHAIR HIGH BACK**

Maximum 2 low chairs high back per box
 Gross weight (kg): 16,95 kg | Net weight (kg): 11,16

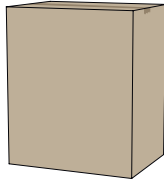
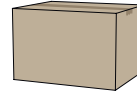
**BOX 3: FOOTREST****BOX 4: LOUNGE CHAIR**

Maximum 2 lounge chairs per box: Gross weight (kg): 23,84 kg |
 Net weight (kg): 13,84

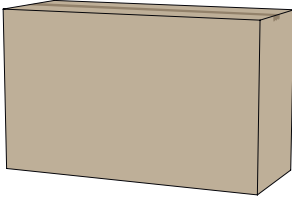
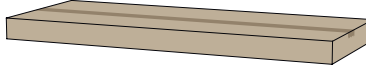
**BOX 5: SUNBED**

Box dimensions (mm)		L	W	H	Qty (#)	Volume (m ³)	Gross weight (kg)	Net weight (kg)	Packaging weight (kg)
Chair	Box 1	793	680	940	1	0,51	10,04	4,89	5,15
Low chair high back	Box 2	800	590	960	1	0,45	11,14	5,35	5,79
Footrest	Box 3	650	515	430	1	0,14	6,68	4,18	2,50
Lounge chair	Box 4	1645	665	1000	1	1,09	16,69	6,69	10,00
Sunbed	Box 5	2100	840	130	1	0,26	85,52	80,99	4,53

Standard table

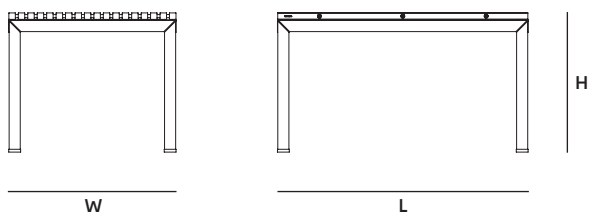

Dimensions (mm)	L	W	H
Standard table 135	1350	900	750
Standard table 180	1800	900	750
Standard table 225	2250	900	750
Standard table 270	2700	900	750

BOX 6: TABLETOP + LEGS + MOUNTING KIT

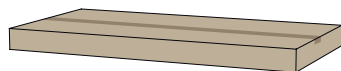

Box dimensions (mm)		L	W	H	Qty (#)	Volume (m ³)	Gross weight (kg)	Net weight (kg)	Packaging weight (kg)
Standard table 135	Box 6	1380	930	130	1	0,18	61,04	56,00	5,04
Standard table 180	Box 6	1830	930	130	1	0,23	75,64	69,94	5,70
Standard table 225	Box 6	2280	930	130	1	0,29	94,41	87,32	7,09
Standard table 270	Box 6	2730	930	130	1	0,33	105,51	98,42	7,09

The tables below have the same length and width as the standard tables but have a different height:

- Medium table: **H** 690 mm **Weight** = Net weight of Standard table - 0,34 kg
- Low table: **H** 450 mm **Weight** = Net weight of Standard table - 1,70 kg
- Extra low table: **H** 230 mm **Weight** = Net weight of Standard table - 2,95 kg

Standard square table

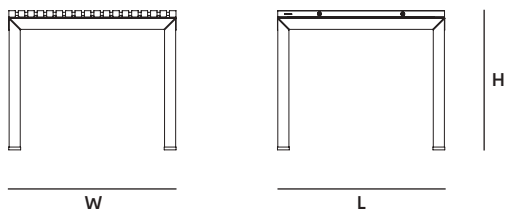

Dimensions (mm)	L	W	H
Standard square table 75	750	750	750
Standard square table 80	800	800	750
Standard square table 90	900	900	750

BOX 7: TABLETOP + LEGS + MOUNTING KIT



Box dimensions (mm)		L	W	H	Qty (#)	Volume (m ³)	Gross weight (kg)	Net weight (kg)	Packaging weight (kg)
Standard square table 75	Box 7	780	780	135	1	0,08	49,63	45,50	4,13
Standard square table 80	Box 7	830	830	135	1	0,09	50,85	46,52	4,33
Standard square table 90	Box 7	930	930	135	1	0,12	52,06	47,53	4,53

The tables below have the same length and width as the standard square tables but have a different height:

- Medium square table: **H** 690 mm **Weight** = Net weight of Standard table - 0,34 kg
- Low square table: **H** 450 mm **Weight** = Net weight of Standard table - 1,70 kg
- Extra low square table: **H** 230 mm **Weight** = Net weight of Standard table - 2,95 kg

Bench

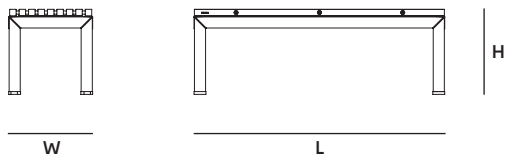

Dimensions (mm)	L	W	H
Bench 90	900	450	450
Bench 135	1350	450	450
Bench 180	1800	450	450
Bench 225	2250	450	450
Bench 270	2700	450	450

BOX 8: BENCHTOP + LEGS + MOUNTING KIT



Box dimensions (mm)		L	W	H	Qty (#)	Volume (m ³)	Gross weight (kg)	Net weight (kg)	Packaging weight (kg)
Bench 90	Box 8	930	480	130	1	0,06	28,41	27,41	1,00
Bench 135	Box 8	1380	480	130	1	0,09	37,54	35,99	1,55
Bench 180	Box 8	1830	480	130	1	0,11	46,08	44,15	1,93
Bench 225	Box 8	2280	480	130	1	0,14	58,11	55,36	2,75
Bench 270	Box 8	2730	480	130	1	0,17	66,36	63,61	2,75

Bench with backrest

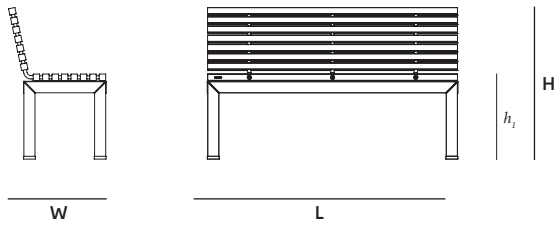

Dimensions (mm)	L	W	H	h_1
Bench with backrest 135	1350	527	810	450
Bench with backrest 180	1800	527	810	450
Bench with backrest 225	2250	527	810	450
Bench with backrest 270	2700	527	810	450

BOX 9: BENCHTOP WITH BACKREST + LEGS + MOUNTING KIT

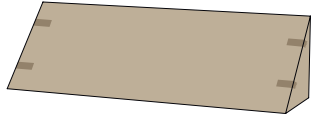

Box dimensions (mm)		L	W	H	Qty (#)	Volume (m ³)	Gross weight (kg)	Net weight (kg)	Packaging weight (kg)
Bench with backrest 135	Box 9	1550	550	495	1	0,42	50,72	49,02	1,70
Bench with backrest 180	Box 9	2000	550	495	1	0,54	64,43	61,37	3,06
Bench with backrest 225	Box 9	2450	550	495	1	0,67	81,51	77,06	4,45
Bench with backrest 270	Box 9	2900	550	495	1	0,79	94,88	90,53	4,45

Bench with back- & armrest

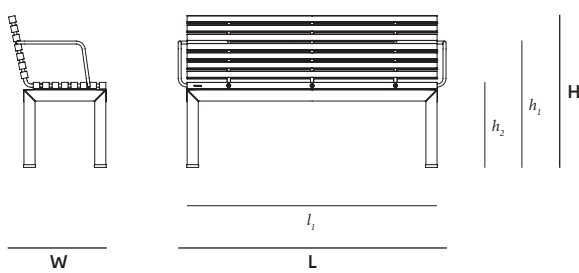

Dimensions (mm)	L	W	H	l_1	h_1	h_2
Bench with back- & armrest 135	1550	527	810	1450	680	450
Bench with back- & armrest 180	2000	527	810	1900	680	450
Bench with back- & armrest 225	2450	527	810	2350	680	450
Bench with back- & armrest 270	2900	527	810	2800	680	450

BOX 10: BENCHTOP WITH BACK- & ARMREST + LEGS + MOUNTING KIT

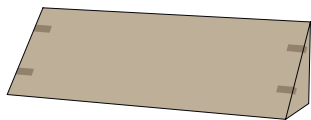

Box dimensions (mm)		L	W	H	Qty (#)	Volume (m ³)	Gross weight (kg)	Net weight (kg)	Packaging weight (kg)
Bench with back- & armrest 135	Box 10	1380	480	500	1	0,33	52,79	51,09	1,70
Bench with back- & armrest 180	Box 10	1830	480	500	1	0,44	60,38	63,44	3,06
Bench with back- & armrest 225	Box 10	2280	480	500	1	0,55	84,63	80,18	4,45
Bench with back- & armrest 270	Box 10	2730	480	500	1	0,66	95,91	91,46	4,45

Table extra high

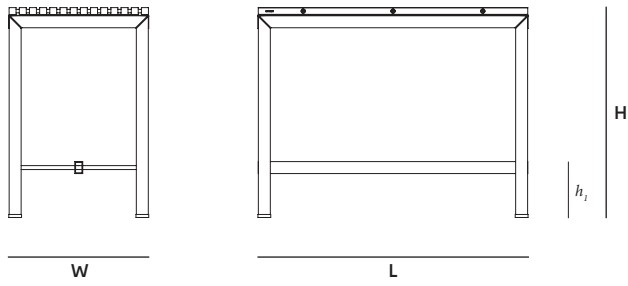

Dimensions (mm)	L	W	H	h_1
Table extra high 135	1350	700	1050	270
Table extra high 270	2700	700	1050	270

BOX 11: TABLETOP + MOUNTING KIT



BOX 12: FOOTREST



Box dimensions (mm)		L	W	H	Qty (#)	Volume (m ³)	Gross weight (kg)	Net weight (kg)	Packaging weight (kg)
Table extra high 135	Box 11	1380	740	135	1	0,14	58,18	55,70	2,48
	Box 12	1380	70	50	1	0,01	8,68	6,20	2,48
					total:	0,15	68,86	63,90	4,96
Table extra high 270	Box 11	2730	740	135	1	0,27	96,09	91,56	4,53
	Box 12	2730	70	50	1	0,01	13,04	8,94	4,10
					total:	0,28	109,13	100,50	8,63

Bench extra high

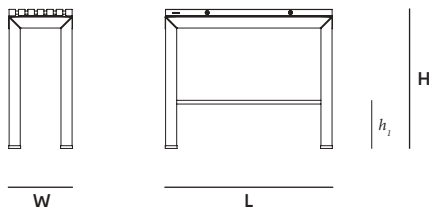

Dimensions (mm)	L	W	H	h_1
Bench extra high	900	340	750	270

BOX 13: BENCHTOP + MOUNTING KIT



BOX 14: FOOTREST



Box dimensions (mm)		L	W	H	Qty (#)	Volume (m ³)	Gross weight (kg)	Net weight (kg)	Packaging weight (kg)
Bench extra high	Box 13	930	370	135	1	0,05	31,98	27,45	4,53
	Box 14	930	70	50	1	0,01	2,83	0,78	2,05
					total:	0,06	34,81	28,23	6,58

Materials & colours

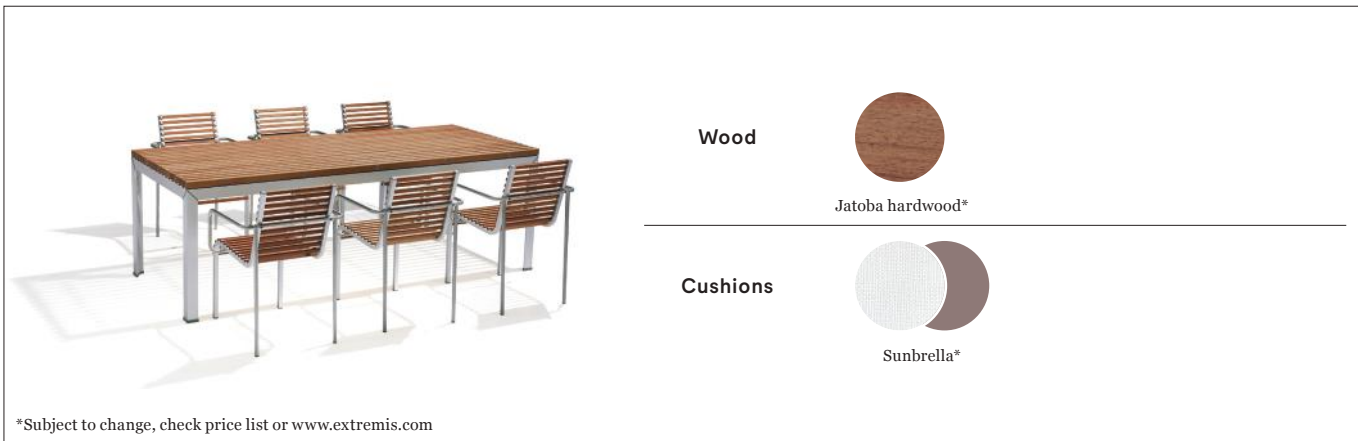

*Subject to change, check price list or www.extremis.com

Materials	Key facts	Thickness mm	Layer thickness micron	Density	In/outdoor	Water	UV colour fastness	Flame retarding
Jatoba hardwood	<ul style="list-style-type: none"> • Durability CLASS 1 • Exceptional quality • Characteristics: durability & stability • Bleeds when wood is exposed to rain for the first few times • The dye is water-soluble • Feels comfortable in all weather conditions 	18 - 35	n.a.	850 kg/m ³	Outdoor & indoor	n.a.	Untreated wood turns grey after a while	/
Anodised aluminium frame & legs (chairs, benches & tables)	<ul style="list-style-type: none"> • A process aimed at thickening the existing aluminium oxide layer • Thickest layer of protection 	3 - 10	50 - 100	2,70 10 ³ kg/m ³	Outdoor & indoor	n.a.	Very good	NEN-EN 13501-1 A1*
Stainless steel legs AISI 316 (chairs)	<ul style="list-style-type: none"> • Highest stainless steel quality available (AISI 316) • High rust resistance • Periodical maintenance required 	2 - 8	n.a.	8,00 10 ³ kg/m ³	Outdoor & indoor	n.a.	Very good	NEN-EN 13501-1 A1*
Sunbrella cushions	<ul style="list-style-type: none"> • 100% Sunbrella Acrylic • Best outdoor fabric available for making cushions • Dirt repellent • Not waterproof, store inside! • Machine washable at max. 30°C. Ironing restores the protective layer 	0,50	n.a.	260 g/m ²	Outdoor & indoor	The fabric has a water column of 35mbar (EN 20811)	7/8 (ISO 105-B02)	/

* NEN-EN13501-1 A1

Class A1 products will not contribute to fire in any stage, including fully developed fire. For this reason, they are assumed to be capable of satisfying all requirements of all lower classes as well

Warnings

General

- Do not use any sharp tools to open the packaging.
- We strongly advise against using power tools.
- Tripping hazard, mind your step.
- Do not put out cigarettes on the table chairs & benches.
- Not graffiti proof.
- Do not leave children unattended whilst playing on the table.
- To avoid danger of suffocation, keep plastic bags away from babies and children.
- Colours can differ over years and from batch to batch.

Product

- Do not drag the table, but carry it with minimum 2 people.
- Anchoring the product has to be done by qualified people.
- For anchoring: use suitable bolts or screws from a specialized store depending on the material your terrace is made of.

Wood

- When delivered, the wood is untreated.

- The wood can bleed when it's exposed to rain for the first few times.
- Wood is a natural material and its look is different for every slat, plank and tree.
- Wood will gradually become rougher and start to turn grey as a consequence of exposure to the sun and rain. We recommend oiling the wood at regular intervals depending from location and general weather conditions.
- Clean regularly with mild detergent. Never use a high pressure cleaner as this will roughen the wood's smooth surface and irreparably damage the wood's fiber.
- Thorough cleaning with Extremis Wood Cleaner.
- We strongly recommend that you treat your wood with wood protector to protect it from stains - Small cracks and crevices can also appear as part of this process. We strongly advise everyone to treat the furniture with our Wood Protector.

Stainless steel

- Very good UV colour fastness.
- Flame retarding: NEN-EN13501-1 A1 - Class A1 products will not contribute to fire in any stage,

including fully developed fire. For this reason, they are assumed to be capable of satisfying all requirements of all lower classes as well.

- Watch out, stainless steel isn't entirely rustproof! Be sure to avoid contact with iron objects. If it does show signs of rust, clean with rust remover as quickly as possible.

Sunbrella

- Not waterproof, store inside!
- Shake or brush off loose dirt immediately.
- UV colour fastness: 7/8 (ISO 105-B02).

Anodised aluminium

- Do not use abrasive scouring powders or scourers as they will scratch the surface.
- Colour can fade to some extent when exposed to UV.
- Flame retarding - NEN-EN13501-1 A2-sl - Satisfying the same criteria as Class B for the SBI-test according to EN13823. In addition, under conditions of a fully developed fire these products will not significantly contribute to the fire load and fire growth.
- Dark colors can get very hot in sunny weather.

Applications

Residential: Extempore is a complete range for the garden. **Project:** hotel and catering industry, company terraces, public spaces, ...

F.a.q.

Q: Do you need to oil the wood?

A: Just like other types of wood, Iroko will gradually become rougher and start to turn grey as a consequence of exposure to the sun and rain. Small cracks and crevices can also appear as part of this process. We strongly advise everyone to treat the furniture with our Wood Protector. This 100% natural oil controls the moisture level within the wood, which makes the planks stay stable for longer, and the layer of oil also helps to prevent spilled liquids from being absorbed, so that stains tend to stay superficial. It is best to repeat this treatment at regular intervals.

Maintenance

Find maintenance instructions at the downloads section of extremis.com for:

WOOD

- Clean regularly with mild detergent.
- Thorough cleaning with Extremis Wood Cleaner.
- Oil the wood with Extremis Wood Protector. We recommend oiling the wood at regular intervals depending from location and general weather conditions.
- In order to smoothen the surface again after a thorough cleaning, lightly sand your wood with 80 grit sanding paper or a sanding pad.

STAINLESS STEEL

- Clean regularly with a dry cloth and some stainless steel cleaner.

ANODISED PARTS

- Clean with lukewarm water and a mild detergent or with Extremis Multi Cleaner.

Floor fastening

Extempore comes with an optional floor anchoring set.

Good to know

- There are cushions available for all chairs and benches.
- There are optional wheels available for all tables and sunbed.



Website

www.extremis.com/extempore