

Dimensions

The AMAi is available in one dimension

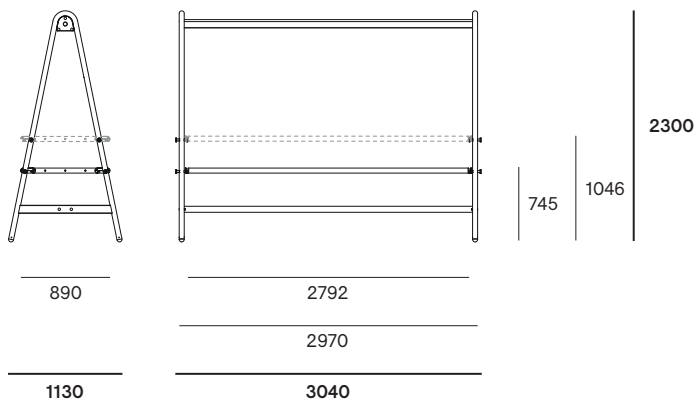

Box dimensions

The AMAi comes in 6 boxes

Box 1: A-frame (2x)

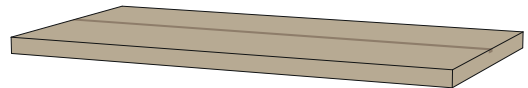

Box 2: Tabletop

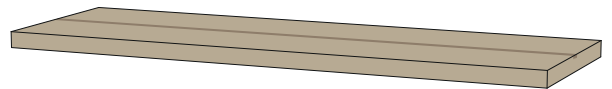

Box 3: Footrest



Box 4: Top profile/tube

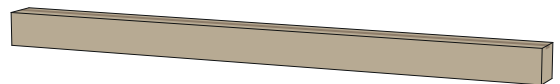

Box 5: Mounting kit



Box dimensions (mm)		L	W	H	Qty	Volume (m3)	Gross weight (kg)	Net weight (kg)	Packaging weight (kg)
Powder coated version	Box 1	2350	1200	84	2	0,47	37,2	32,20	5,00
(with powder coated tabletop)	Box 2	2900	940	84	1	0,23	54,30	52,30	2,00
	Box 3	2900	190	70	1	0,04	10,70	9,50	1,20
	Box 4	2915	180	150	1	0,09	18,90	16,90	2,00
	Box 5	200	150	90	1	0,01	0,60	0,50	0,10
	Total:					0,84	121,70	111,40	10,30
Galvanized version	Box 1	2350	1200	84	2	0,47	37,2	32,20	5,00
(with powder coated tabletop)	Box 2	2900	940	84	1	0,23	54,30	52,30	2,00
	Box 3	2900	190	70	1	0,04	10,70	9,50	1,20
	Box 4	2915	180	150	1	0,09	11,90	9,90	2,00
	Box 5	200	150	90	1	0,01	0,60	0,50	0,10
	Total:					0,84	114,70	104,40	10,30

Extension module

The extension module is available in one dimension

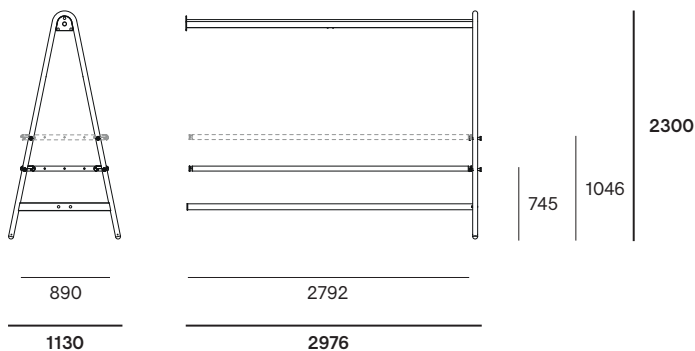

Box dimensions

The extension module comes in 5 boxes

Box 1: A-frame (1x)

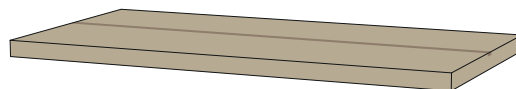

Box 2: Tabletop

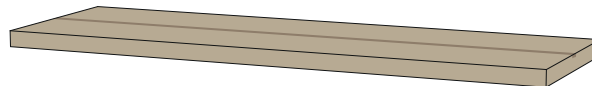

Box 3: Footrest



Box 4: Top profile/tube

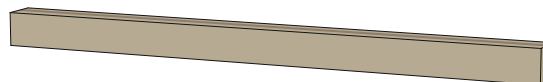

Box 6: Mounting kit extension



Box dimensions (mm)		L	W	H	Qty	Volume (m ³)	Gross weight (kg)	Net weight (kg)	Packaging weight (kg)
Powder coated version	Box 1	2350	1200	84	1	0,24	18,60	16,10	2,50
(with powder coated tabletop)	Box 2	2900	940	84	1	0,23	54,30	52,30	2,00
	Box 3	2900	190	70	1	0,04	10,70	9,50	1,20
	Box 4	2915	180	150	1	0,09	18,90	16,90	2,00
	Box 6	200	150	90	1	0,01	0,60	0,50	0,10
	Total:					0,61	103,10	95,30	7,80
Galvanized version	Box 1	2350	1200	84	1	0,24	18,60	16,10	2,50
(with powder coated tabletop)	Box 2	2900	940	84	1	0,23	54,30	52,30	2,00
	Box 3	2900	190	70	1	0,04	10,70	9,50	1,20
	Box 4	2915	180	150	1	0,09	11,90	9,90	2,00
	Box 6	200	150	90	1	0,01	0,60	0,50	0,10
	Total:					0,61	96,10	88,30	7,80

Tabletop options

The tabletop is available in one dimension

There are multiple material options for the tabletop center plate

Tabletop center plates	Gross weight (kg)	Net weight (kg)	Packaging weight (kg)
Powder coated	54,30	52,30	2,00
Hellwood	144,00	142,00	2,00
Soft desktop (indoor)	54,30	52,30	2,00
Oak veneer (indoor)	54,30	52,30	2,00

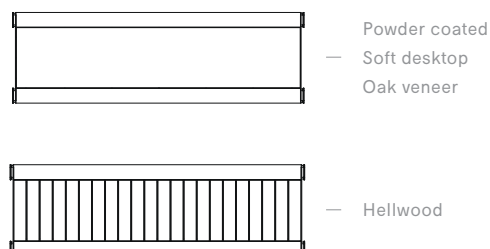

Outdoor/indoor lighting & electricity module

The lighting & electricity module is available in one dimension

2 dimmable [LED lights](#) in the centre of the profile

Color temperature of 3000K (warm white)

Beam angle of 50°

1380 mA / 46 W / 50-60 Hz / IP54

Europe: 220 V / US: 120 V / Japan: 100 V

[Electrical Plug](#)

16 A — 250 V

[USB & USBC module](#)

3 A — 5 V — 15 W

Box dimensions

The lighting & electricity module comes in 1 box

[Box 7](#): lighting & electricity module

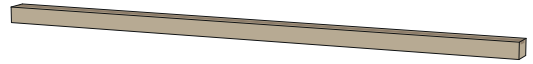

Lighting, electricity & usb module

With LED lights, 2 sockets & 2 usb ports (1 of each left & right)

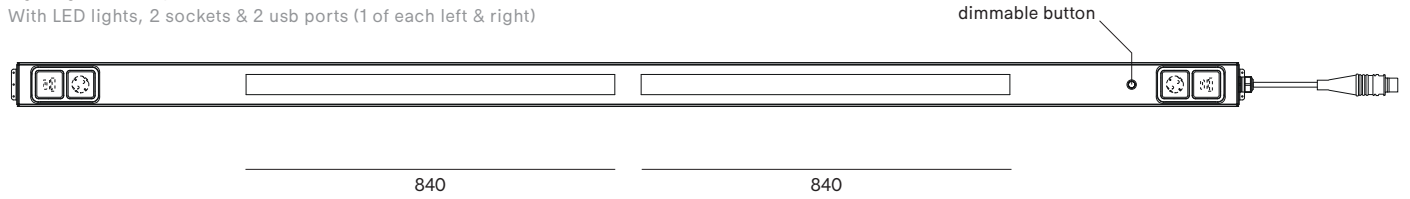

Box dimensions (mm)		L	W	H	Qty	Volume (m ³)	Gross weight (kg)	Net weight (kg)	Packaging weight (kg)
Outdoor lighting & electricity module	Box 7	2825	120	85	1	0,03	17,00	15,00	2,00

Types of electrical plugs

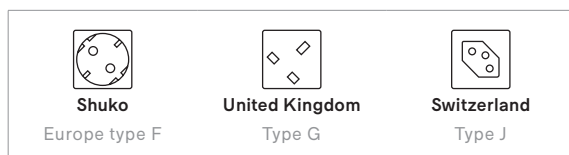

Type of USB module

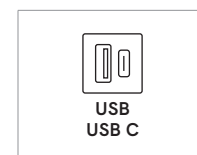

Indoor lighting & electricity module

Each lighting & electricity module is available in one dimension

1 dimmable [LED light](#) in the centre of the profile
 Color temperature of 3000K (warm white)
 Beam angle of 50°
 1380 mA / 46 W / 50-60 Hz / IP20
 Europe: 220 V / US: 120 V / Japan: 100 V

Electrical Plug

16 A — 250 V

USB & USBC module

3 A — 5 V — 15 W

Lighting, electricity & usb module

With LED lights, 2 sockets & 2 usb ports (1 of each left & right)

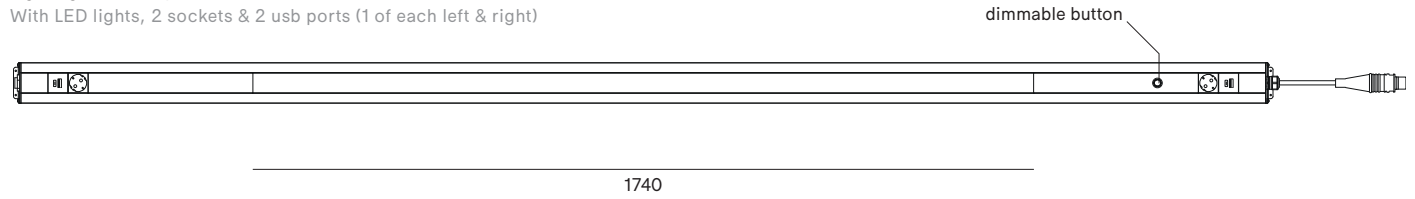

Box dimensions (mm)		L	W	H	Qty	Volume (m ³)	Gross weight (kg)	Net weight (kg)	Packaging weight (kg)
Indoor lighting & electricity module	Box 8	2825	120	85	1	0,03	17,00	15,00	2,00

Types of electrical plugs

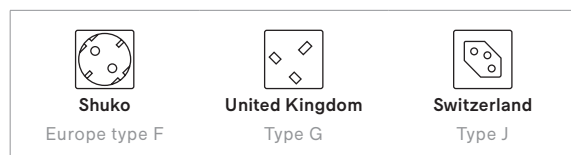

Type of USB module

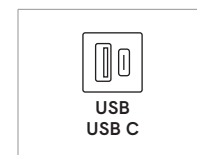

Box dimensions

The lighting & electricity modules come in 1 box each

[Box 8](#): lighting & electricity module



Add-on table

The add-on table is available in one dimension

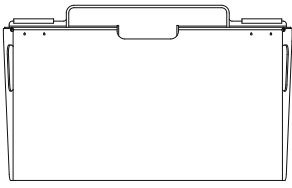

190

516

888

934

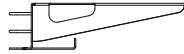

150

397

64

190

472

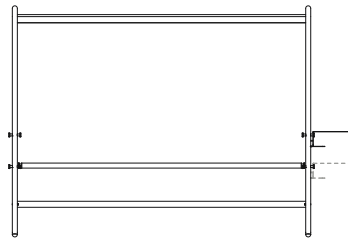
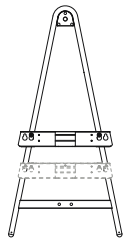

745

1046

3427

Box dimensions

The add-on table comes in 1 box

Box 10: Add-on table



Box dimensions (mm)		L	W	H	Qty	Volume (m ³)	Gross weight (kg)	Net weight (kg)	Packaging weight (kg)
Add-on table	Box 10	940	475	150	1	0,07	13,50	12,80	0,70

Shade

The shade is available in one dimension

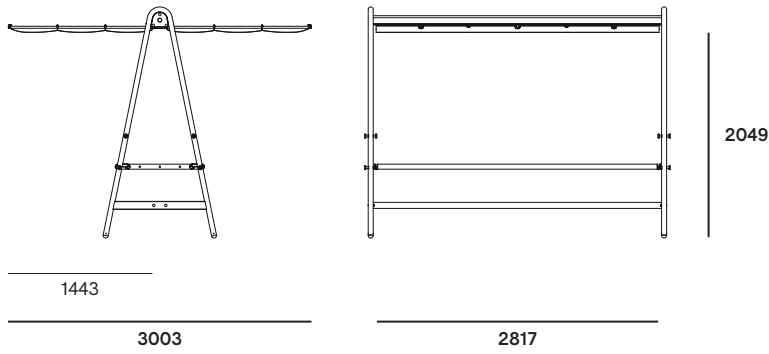

Box dimensions

The shade comes in 1 box

Box 11: Fabric + supports

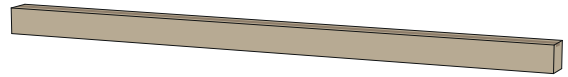

Box dimensions (mm)		L	W	H	Qty	Volume (m3)	Gross weight (kg)	Net weight (kg)	Packaging weight (kg)
Shade (1 set)	Box 11	3015	146	140	1	0,06	12,00	10,00	2,00

Market shade

The market shade is available in one dimension

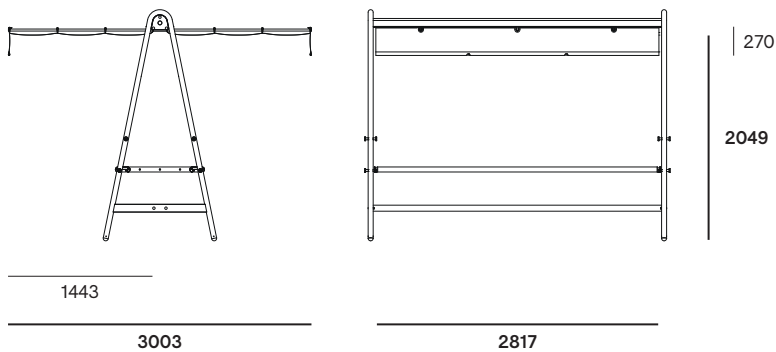

Box dimensions

The market shade comes in 1 box

Box 12: Fabric + supports

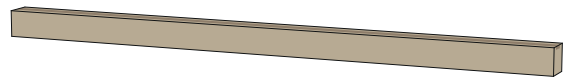

Box dimensions (mm)		L	W	H	Qty	Volume (m3)	Gross weight (kg)	Net weight (kg)	Packaging weight (kg)
Market shade (1 set)	Box 12	3015	146	140	1	0,06	13,00	11,00	2,00

Screenholder

The screenholder is available in one dimension

Vesa connection for computer monitor, not for a television

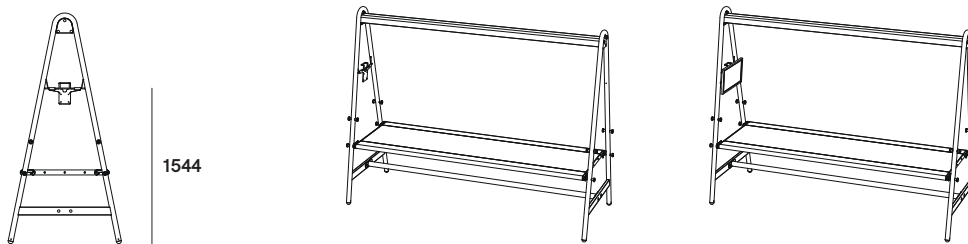
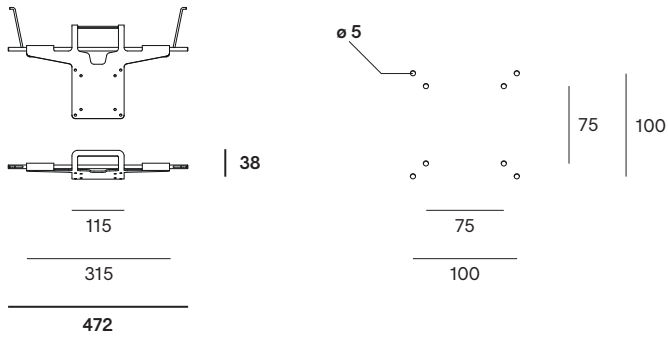

Box dimensions

The screenholder comes in 1 box

Box 13: screenholder



Box dimensions (mm)		L	W	H	Qty	Volume (m ³)	Gross weight (kg)	Net weight (kg)	Packaging weight (kg)
Screenholder	Box 13	400	300	100	1	0,01	1,50	1,30	0,20

Tabletop fixation

The tabletop fixation is available in one dimension

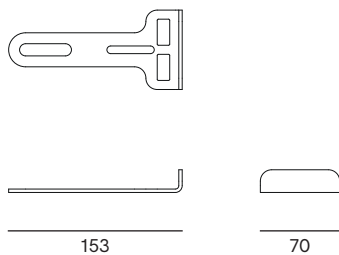

Box dimensions

The tabletop fixation comes in 1 box

Box 14: tabletop fixation (2x)



Box dimensions (mm)		L	W	H	Qty	Volume (m ³)	Gross weight (kg)	Net weight (kg)	Packaging weight (kg)
Tabletop fixation	Box 14	200	150	90	1	0,01	0,30	0,20	0,10

Leveling feet

The leveling feet is available in one dimension

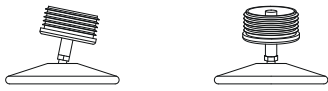

ø100

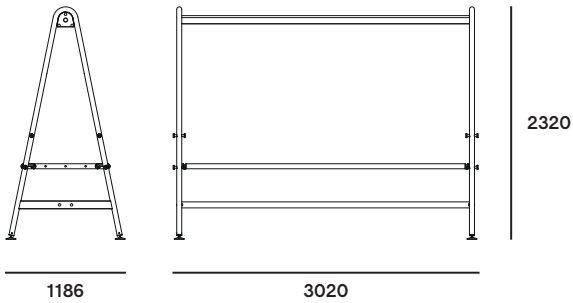

Box dimensions

The leveling feet comes in 1 box

Box 15: leveling feet (4x)



Box dimensions (mm)		L	W	H	Qty	Volume (m ³)	Gross weight (kg)	Net weight (kg)	Packaging weight (kg)
Leveling feet	Box 15	200	150	90	1	0,01	0,60	0,50	0,10

Floor fastening

The floor fastening is available in one dimension

The height of the floor fastening can also be adjusted.

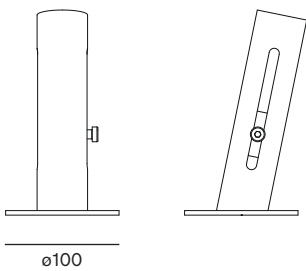
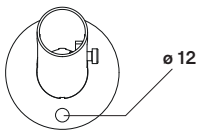

ø100

Box dimensions



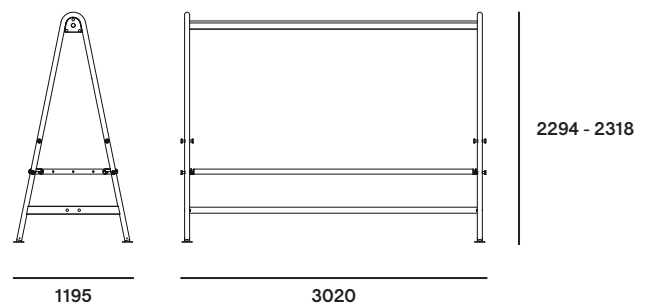

The floor fastening comes in 1 box

Box 16: floor fastening (4x)





Box dimensions (inch)		L	W	H	Qty	Volume (m ³)	Gross weight (kg)	Net weight (kg)	Packaging weight (kg)
Floor fastening	Box 16	200	150	90	1	0,01	0,70	0,60	0,10







A-frame, endcaps & top profile/tube

	Papyrus white (RAL9018) Structured powder coating
	Black (RAL9005) Structured powder coating
	Copper brown (RAL8004) Structured powder coating
	Galvanized steel



Footrest

	Galvanized steel
	Stainless steel 316

Tabletop centreplate

	Papyrus white (RAL9018) Structured powder coating
	Black (RAL9005) Structured powder coating
	Copper brown (RAL8004) Structured powder coating
	Hellwood
	Oak veneer Indoor use only
	Soft desktop Indoor use only

Tabletop side profiles

	Papyrus white (RAL9018) Structured powder coating
	Black (RAL9005) Structured powder coating
	Copper brown (RAL8004) Structured powder coating

Shade fabric

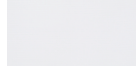
	White High-tech polyester
--	------------------------------



Materials	Key facts	Thickness	Layer thickness	Density	In/outdoor	Water	UV color fastness	Flame retarding
		mm	micron					
Structured powder coated stainless steel A-frame	<ul style="list-style-type: none"> Easy to clean Stainless steel (for protection against rust), then powder coated More scratch-resistant than non structured powder coating 	2	50 - 100	8,00 10 ³ kg/m ³	Outdoor & indoor	n.a.	Very good: color can fade to some extent when exposed to UV	NEN-EN13501-1 A1 *
Hot dip galvanized steel A-frame, top tube, footrest & endcaps	<ul style="list-style-type: none"> Most durable method for protecting metal from rusting Protective layer Very long life span 100% recyclable Cradle to Cradle Certified™ 	2	50 - 100	7,50 10 ³ kg/m ³	Outdoor & indoor	n.a.	Very good, galvanization will however become less shiny when used outdoors	NEN-EN13501-1 A1 *
Structured powder coated aluminium tabletop side profiles & top profile	<ul style="list-style-type: none"> A technique of applying dry paint to a part Electrostatically charged and sprayed onto the object More scratch-resistant than non structured powder coating 	2-10	50 - 100	2,70 10 ³ kg/m ³	Outdoor & indoor	n.a.	Very good: color can fade to some extent when exposed to UV	NEN-EN13501-1 A2-s1 **
Structured powder coated ZnAlMg steel tabletop centreplate	<ul style="list-style-type: none"> A technique of applying dry paint to a part Electrostatically charged and sprayed onto the object More scratch-resistant than non structured powder coated 	2	60	7,50 10 ³ kg/m ³	Outdoor & indoor	n.a.	Very good: color can fade to some extent when exposed to UV	NEN-EN13501-1 A2-s1 **
Hellwood tabletop centreplate	 <ul style="list-style-type: none"> Durability CLASS 1 Carries the PEFC™ label for durable forestry Feels comfortable in all weather conditions Advisable to oil the wood 	24	n.a.	+/- 600 kg/m ³	Outdoor & indoor	n.a.	Untreated wood turns grey after a while	/
Oak veneer tabletop centreplate	<ul style="list-style-type: none"> European oak Thin layer of real wood Environmental friendly processing 	1,5	n.a.	700 kg/m ³	Indoor use only	n.a.	Discoloration when exposed to light	/
Soft desktop tabletop centreplate	<ul style="list-style-type: none"> Furniture linoleum (4178 iron) Flexible Feels comfortable 	2	n.a.	2,10 kg/m ³	Indoor use only	n.a.	Slight discoloration	/
Structured powder coated electro galvanized steel endcaps	<ul style="list-style-type: none"> Easy to clean Electro galvanized (for extra protection against rust), then powder coated More scratch-resistant than non structured powder coating 	6	100	7,50 10 ³ kg/m ³	Outdoor & indoor	n.a.	Very good: color can fade to some extent when exposed to UV	NEN-EN13501-1 A1 *
Stainless steel 316 footrest & shade structure	<ul style="list-style-type: none"> High rust resistance Periodical maintenance required 	2	n.a.	8,00 10 ³ kg/m ³	Outdoor & indoor	n.a.	Very good	NEN-EN13501-1 A1 *
High-tech polyester fabric	<ul style="list-style-type: none"> High UV resistance and ultra strong Low weight / high tear strength Long-term appearance 	0,37	n.a.	250 g/m ³	Outdoor & indoor	Water column of 350 mm (EN 20811)	7/8 (ISO 105-B02)	/
LED light	<ul style="list-style-type: none"> Color temperature of 3000K Beam angle of 50° 1380 mA 46 W 220 V - 50/60 Hz 	n.a.	n.a.	n.a.	Outdoor & indoor		/	/

NEN-EN13501-1 A1
NEN-EN13501-1 A2-s1

Class A1 products will not contribute to fire in any stage, including fully developed fire. For this reason, they are assumed to be capable of satisfying all requirements of all lower classes as well. Satisfying the same criteria as class B for the SBI-test according to EN 13823. In addition, under conditions of a fully developed fire these products will significantly contribute to the fire load a fire growthwell.

Good to know

- PEFC™ certified wood (Hellwood) originates from sustainably managed forests.
- Casambi Bluetooth electricity module.
- Multiple tabletop center plate options.
- Patented

Floor fastening

AMAI comes with an optional floor anchoring set: four steel plates to be fixed with bolts.

F.A.Q.

Q: *Do you need to oil the wood?*

A: Just like other types of wood, wood will gradually become rougher and start to turn grey as a consequence of exposure to the sun and rain. Small cracks and crevices can also appear as part of this process. We strongly advise everyone to treat the furniture with our Wood Protector. This 100% natural oil controls the moisture level within the wood, which makes the planks stay stable for longer, and the layer of oil also helps to prevent spilled liquids from being absorbed, so that stains tend to stay superficial. It is best to repeat this treatment at regular intervals.

Q: *How wind resistant is the shade?*

A: Tests in a windtunnel have shown that the shade withstands wind speeds up to 6 on the Beaufort scale (49 km/h). Still, we strongly advise to close it sooner (from 4 on the Beaufort scale is the rule of thumb (28 km/h)).

Maintenance

Find maintenance instructions at the product care section of extremis.com for

POWDER COATED PARTS

- White powder coating obviously requires more maintenance.

GALVANIZED PARTS

- How to repair a damaged zinc layer.

SHADE FABRIC

- Shake or brush off loose dirt immediately.
- Spray Extremis Multi Cleaner.
- Use a soft brush and make circular movements.
- Let the suds soak in for a moment.
- Rinse thoroughly to remove all soap residue.
- Simply allow to dry.

WOOD

- Clean regularly with mild detergent.
- Thorough cleaning with Extremis Wood Cleaner.
- Oil the wood with Extremis Wood Protector. We recommend oiling the wood at regular intervals depending from location and general weather conditions.
- In order to smoothen the surface again after a thorough cleaning, lightly sand your wood with 80 grit sanding paper or a sanding pad.

RECOMMENDED USE

- For Extremis Wood protector:



2 to 3 wood care treatments



1 to 2 wood care treatments



300 - 400 ml for one wooden center plate

Warnings

General

- Do not use any sharp tools to open the packaging.
- We strongly advise against using power tools.
- Tripping hazard, mind your step.
- Do not put out cigarettes on the table.
- Do not graffiti proof.
- Do not leave children unattended whilst playing on the table.
- To avoid danger of suffocation, keep plastic bags away from babies and children.
- Colors can differ over years and from batch to batch.

Product

- Do not stand or jump on the table.
- Do not drag the table, but carry it with minimum 2 people.
- Anchoring the product has to be done by qualified people.
- For anchoring: use suitable bolts or screws from a specialized store depending on the material your terrace is made of.
- Tests in a windtunnel have shown that the shade withstands wind speeds up to 6 on the Beaufort scale (49 km/h). Still, we strongly advise to close it sooner (from 4 on the Beaufort scale is the rule of thumb (28 km/h)).

Powder coating

- White powder coating requires more maintenance.
- Do not use abrasive scouring powders or scourers as they will scratch the surface.
- Color can fade to some extent when exposed to UV.
- Flame retarding - NEN-EN13501-1 A2-s1 - Satisfying the same criteria as Class B for the SBI-test according to EN13823. In addition, under conditions of a fully developed fire these products will not significantly contribute to the fire load and fire growth.
- Dark colors can get very hot in sunny weather.

Galvanized steel

- Galvanization will become less shiny when used outdoors.
- Flame retarding - NEN-EN13501-1 A1 - Class A1 products will not contribute to fire in any stage, including fully developed fire. For this reason, they are assumed to be capable of satisfying all requirements of all lower classes as well.
- Possible impurities in the immersion tank can cause black marks during galvanization, which are intrinsic to this industrial finishing technique.
- White marks on this zinc layer are also intrinsic to this procedure and will disappear when the furniture is put outdoors.
- This industrial finishing technique may result in a rougher surface. This is intrinsic to the process.

Wood

- When delivered, the wood is untreated.
- Wood is a natural material and its look is different for every slat, plank and tree.
- Wood will gradually become rougher and start to turn grey as a consequence of exposure to the sun and rain. We recommend oiling the wood at regular intervals depending from location and general weather conditions.
- Clean regularly with mild detergent. Never use a high pressure cleaner as this will roughen the wood's smooth surface and irreparably damage the wood's fiber.
- Thorough cleaning with Extremis Wood Cleaner.
- We strongly recommend that you treat your wood with wood protector to protect it from stains - small cracks and crevices can also appear as part of this process. We strongly advise everyone to treat the furniture with our Wood Protector.

High-tech polyester

- Shake or brush off loose dirt immediately.
- Do not use any aggressive detergents as they will

remove the protective coating of the fabric.

- We strongly advise you not to use a high-pressure hose for cleaning.

Soft desktop

- For indoor use only.
- Spilt liquids such as coffee, tea, alcohol, etc. must be removed immediately.
- Remove ink stains with turpentine or white spirit. Repair any dull spots that may emerge with a Forbo Polish and polish with a worn green scouring pad.

Oak veneer

- For indoor use only.
- Spilt liquids such as coffee, tea, alcohol, etc. and even water should be removed immediately.
- Do not use abrasive cleaning agents or aggressive solvents.
- Do not use wax polish.
- Light will affect the colour of the veneer.
- Temperature and humidity can cause the veneer to shrink or expand.
- Never place hot objects directly on the veneer.

The content of this document, in particular the mentioned models, is protected by copyrights and/or design rights. The present document and its content is communicated to you for information purposes only. Any partial or total reproduction or any other use without our prior written permission is strictly prohibited. This technical sheet remains subject to possible changes. **All dimensions are in mm**, unless mentioned otherwise. Extremis is not responsible for the errors in the documentation of products. All measurements are approximate and are provided for informational purposes only.

Tech sheet

20221223