

# AMAi bench

© design by Dirk Wynants

extremis®



## Dimensions

The AMAi bench is available in one dimension

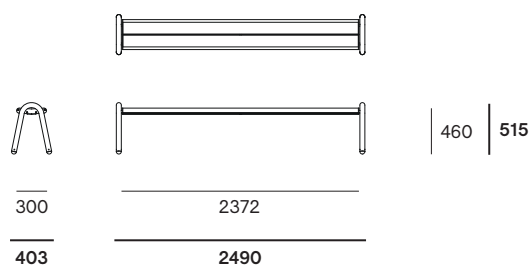

## Box dimensions

The AMAi bench comes in 2 boxes

Box 1: Bench top



Box 2: Legs (2x)



Box dimensions (mm)		L	W	H	Qty	Volume (m <sup>3</sup> )	Gross weight (kg)	Net weight (kg)	Packaging weight (kg)
Bench	Box 1	2386	324	76	1	0,06	19,50	17,50	2,00
	Box 2	554	474	164	1	0,04	6,30	5,30	1,00
Total:						<b>0,10</b>	<b>25,80</b>	<b>22,80</b>	<b>3,00</b>

## Bench profiles & legs



Papyrus white (RAL9018)  
Structured powder coating



Black (RAL9005)  
Structured powder coating



Copper brown (RAL8004)  
Structured powder coating



Materials	Key facts	Thickness mm	Layer thickness micron	Density	In/outdoor	Water	UV color fastness	Flame retarding
Structured powder coated stainless steel legs	<ul style="list-style-type: none"> <li>Easy to clean</li> <li>Stainless steel (for protection against rust), then powder coated</li> <li>More scratch-resistant than non structured powder coating</li> </ul>	2	50 - 100	8,00 10 <sup>3</sup> kg/m <sup>3</sup>	Outdoor & indoor	n.a.	Very good: color can fade to some extent when exposed to UV	NEN-EN13501-1 A1 *
Structured powder coated aluminium bench profiles	<ul style="list-style-type: none"> <li>A technique of applying dry paint to a part</li> <li>Electrostatically charged and sprayed onto the object</li> <li>More scratch-resistant than non structured powder coating</li> </ul>	2-10	50 - 100	2,70 10 <sup>3</sup> kg/m <sup>3</sup>	Outdoor & indoor	n.a.	Very good: color can fade to some extent when exposed to UV	NEN-EN13501-1 A2-s1 **

NEN-EN13501-1 A1 Class A1 products will not contribute to fire in any stage, including fully developed fire. For this reason, they are assumed to be capable of satisfying all requirements of all lower classes as well.  
 NEN-EN13501-1 A2-s1 Satisfying the same criteria as class B for the SBI-test according to EN 13823. In addition, under conditions of a fully developed fire these products will significantly contribute to the fire load a fire growthwell.

## Maintenance

Find maintenance instructions at the [product care](#) section of [extremis.com](http://extremis.com) for

### POWDER COATED PARTS

- White powder coating obviously requires more maintenance.

## Warnings

### General

- Do not use any sharp tools to open the packaging.
- We strongly advise against using power tools.
- Tripping hazard, mind your step.
- Do not put out cigarettes on the bench.
- Not graffiti proof.
- Do not leave children unattended whilst playing on the bench.
- To avoid danger of suffocation, keep plastic bags away from babies and children.
- Colors can differ over years and from batch to batch.

### Product

- Do not stand or jump on the bench.
- Do not drag the bench, but carry it with minimum 2 people.

### Powder coating

- White powder coating requires more maintenance.
- Do not use abrasive scouring powders or scourers as they will scratch the surface.
- Color can fade to some extent when exposed to UV.
- Flame retarding - NEN-EN13501-1 A2-s1 - Satisfying the same criteria as Class B for the

SBI-test according to EN13823. In addition, under conditions of a fully developed fire these products will not significantly contribute to the fire load and fire growth.

- Dark colors can get very hot in sunny weather.

The content of this document, in particular the mentioned models, is protected by copyrights and/or design rights. The present document and its content is communicated to you for information purposes only. Any partial or total reproduction or any other use without our prior written permission is strictly prohibited. This technical sheet remains subject to possible changes. **All dimensions are in mm**, unless mentioned otherwise. Extremis is not responsible for the errors in the documentation of products. All measurements are approximate and are provided for informational purposes only.

**Tech sheet**  
20221216

# AMAi HiLo bench

© design by Dirk Wynants

extremis®



## Dimensions

The AMAi HiLo bench is available in two dimensions  
AMAi HiLo bench short

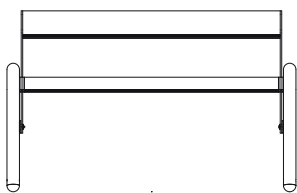
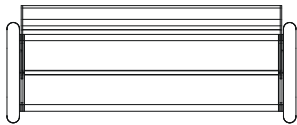

1044

1158

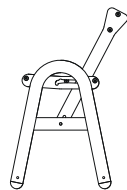

403

470

450

723

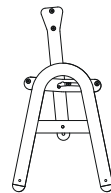

403

740

## Box dimensions

The AMAi HiLo bench short comes in 3 boxes

Box 1: Bench top

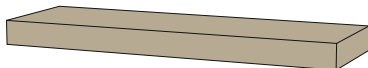

Box 2: Backrest



Box 3: Legs

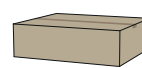

Box dimensions (mm)		L	W	H	Qty	Volume (m3)	Gross weight (kg)	Net weight (kg)	Packaging weight (kg)
HiLo bench short	Box 1	1070	340	76	1	0,30	9,20	8,30	0,90
	Box 2	1050	100	100	1	0,01	4,00	3,00	1,00
	Box 3	570	460	174	1	0,05	12,00	11,30	0,70
Total:						<b>0,36</b>	<b>25,20</b>	<b>22,60</b>	<b>2,60</b>

# Dimensions

AMAI HiLo bench long

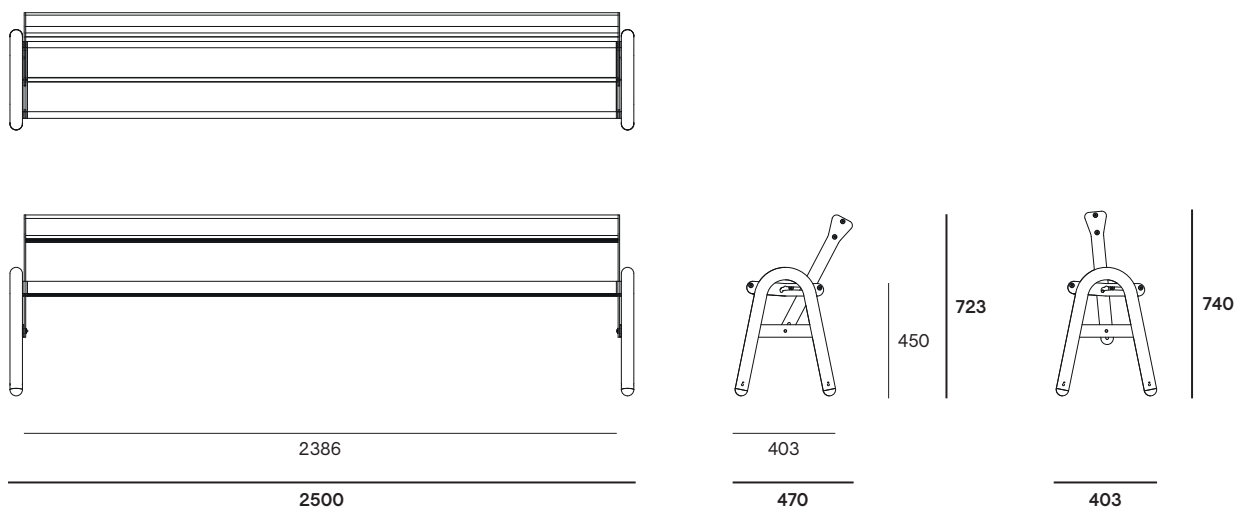

# Box dimensions

The AMAi HiLo bench long comes in 3 boxes

Box 1: Bench top

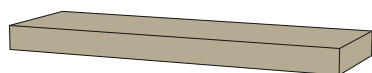

Box 2: Backrest



Box 3: Legs

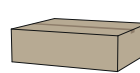

Box dimensions (mm)		L	W	H	Qty	Volume (m <sup>3</sup> )	Gross weight (kg)	Net weight (kg)	Packaging weight (kg)
HiLo bench long	Box 1	2382	324	76	1	0,06	19,40	17,40	2,00
	Box 2	2394	100	100	1	0,02	9,10	7,10	2,00
	Box 3	570	460	174	1	0,05	12,00	11,30	0,70
Total:						<b>0,13</b>	<b>40,50</b>	<b>35,80</b>	<b>4,70</b>

## Bench profiles, legs & backrest

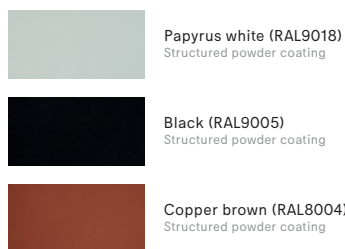

## Sunbrella® cushions

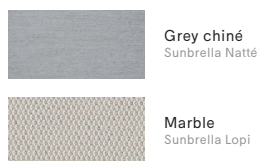

Materials	Key facts	Thickness mm	Layer thickness micron	Density	In/outdoor	Water	UV color fastness	Flame retarding
Structured powder coated stainless steel legs	<ul style="list-style-type: none"> <li>Easy to clean</li> <li>Stainless steel (for protection against rust), then powder coated</li> <li>More scratch-resistant than non structured powder coating</li> </ul>	2	50 - 100	8,00 10 <sup>3</sup> kg/m <sup>3</sup>	Outdoor & indoor	n.a.	Very good: color can fade to some extent when exposed to UV	NEN-EN13501-1 A1 *
Structured powder coated aluminium bench profiles	<ul style="list-style-type: none"> <li>A technique of applying dry paint to a part</li> <li>Electrostatically charged and sprayed onto the object</li> <li>More scratch-resistant than non structured powder coating</li> </ul>	2-10	50 - 100	2,70 10 <sup>3</sup> kg/m <sup>3</sup>	Outdoor & indoor	n.a.	Very good: color can fade to some extent when exposed to UV	NEN-EN13501-1 A2-s1 **
Sunbrella® cushions	<ul style="list-style-type: none"> <li>100% Sunbrella Acrylic</li> <li>Best outdoor fabric available for making cushions</li> <li>Dirt repellent</li> <li>Not waterproof, store inside!</li> <li>Machine washable at max. 30°C. Ironing restores the protective layer</li> </ul>	0,50	n.a.	260 g/m <sup>2</sup>	Outdoor & indoor	The fabric has a water column of 350 mm (EN 20811)	7/8 (ISO 105-B02)	/

NEN-EN13501-1 A1 Class A1 products will not contribute to fire in any stage, including fully developed fire. For this reason, they are assumed to be capable of satisfying all requirements of all lower classes as well.  
 NEN-EN13501-1 A2-sl Satisfying the same criteria as class B for the SBI-test according to EN 13823. In addition, under conditions of a fully developed fire these products will significantly contribute to the fire load a fire growthwell.

## Maintenance

Find maintenance instructions at the [product care](#) section of [extremis.com](http://extremis.com) for

### POWDER COATED PARTS

- White powder coating obviously requires more maintenance.

### SUNBRELLA

- Shake or brush off loose dirt immediately.
- Spray Extremis Multi Cleaner.
- Use a soft brush and make circular movements.
- Let the suds soak in for a moment.
- Rinse thoroughly to remove all soap residue.
- Simply allow to dry.
- It's also possible to put the blanket and the pillow covers in a washing machine (max 40°C). Follow the cleaning instruction on the label

## Warnings

### General

- Do not use any sharp tools to open the packaging.
- We strongly advise against using power tools.
- Tripping hazard, mind your step.
- Do not put out cigarettes on the bench.
- Not graffiti proof.
- Do not leave children unattended whilst playing on the bench.
- To avoid danger of suffocation, keep plastic bags away from babies and children.
- Colors can differ over years and from batch to batch.

### Product

- Do not stand or jump on the bench.
- Do not drag the bench, but carry it with minimum 2 people.
- Short version: Max. 3 people or 240 kg per bench.
- Long version: Max. 5 people or 400 kg per bench.

### Powder coating

- White powder coating requires more maintenance.
- Do not use abrasive scouring powders or scourers as they will scratch the surface.
- Color can fade to some extent when exposed to UV.

- Flame retarding - NEN-EN13501-1 A2-sl - Satisfying the same criteria as Class B for the SBI-test according to EN13823. In addition, under conditions of a fully developed fire these products will not significantly contribute to the fire load and fire growth.
- Dark colors can get very hot in sunny weather.

### Sunbrella

- Not waterproof, store inside!
- Shake or brush off loose dirt immediately.
- UV color fastness: 7/8 (ISO 105-B02).

The content of this document, in particular the mentioned models, is protected by copyrights and/or design rights. The present document and its content is communicated to you for information purposes only. Any partial or total reproduction or any other use without our prior written permission is strictly prohibited. This technical sheet remains subject to possible changes. **All dimensions are in mm**, unless mentioned otherwise. Extremis is not responsible for the errors in the documentation of products. All measurements are approximate and are provided for informational purposes only.

**Tech sheet**  
20230105