

Kosmos shade

© Design by Dirk Wynants for Extremis, 2008

extremis®



Dimensions

The Kosmos round shade is available in 2 heights
In combination with floor fastening

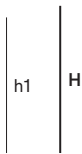
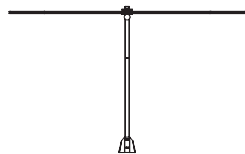
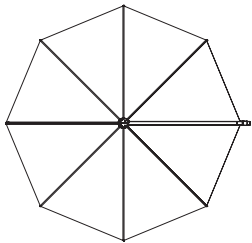

Dimensions (mm)	H	h1
Round shade	2005	1905
Round shade high	2154	2054

ø3266

3387

In combination with concrete base

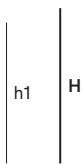
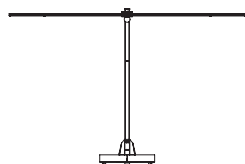
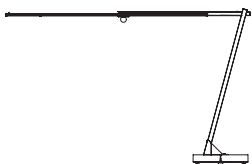

Dimensions (mm)	H	h1
Round shade	2137	2032
Round shade high	2285	2180

ø3266

3387

In combination with concrete wheel base

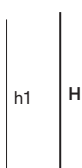
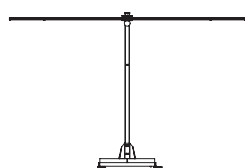
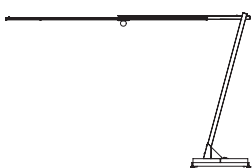

Dimensions (mm)	H	h1
Round shade	2215	2110
Round shade high	2363	2258

ø3266

3387

In combination with Kosmos 8-seater

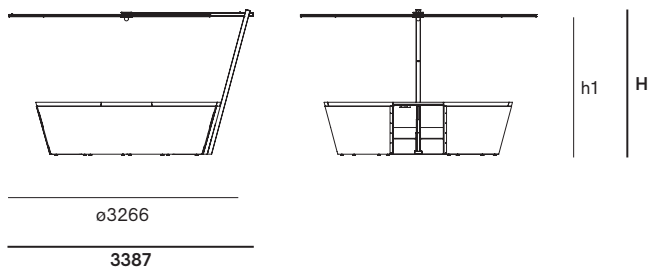

Dimensions (mm)	H	h1
Round shade	2005	1905
Round shade high	2154	2054

The Kosmos square shade is available in 2 heights
In combination with floor fastening

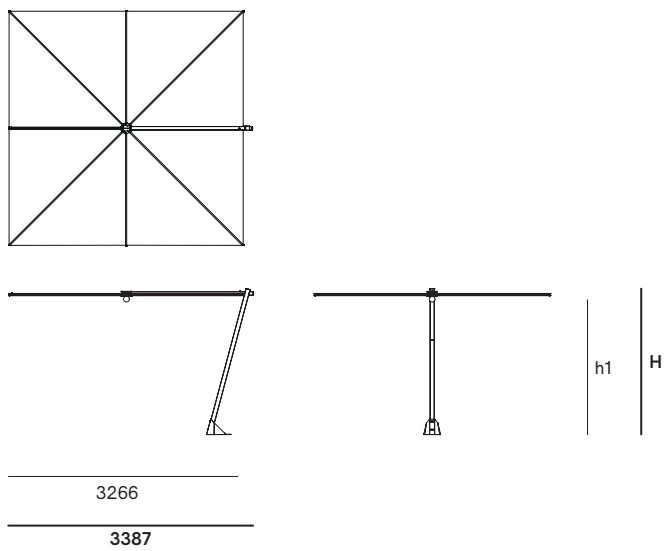

Dimensions (mm)	H	h1
Square shade	2005	1905
Square shade high	2154	2054

In combination with concrete base

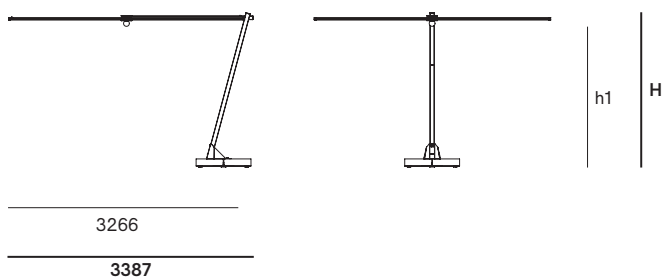

Dimensions (mm)	H	h1
Square shade	2137	2032
Square shade high	2285	2180

In combination with concrete wheel base

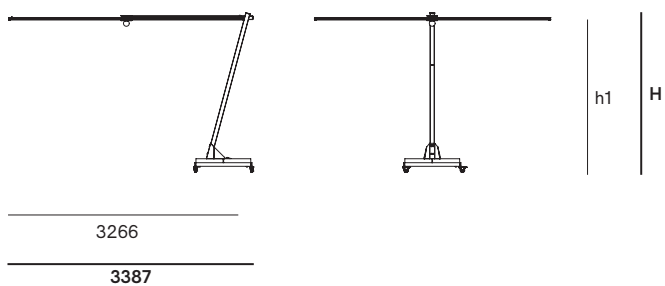

Dimensions (mm)	H	h1
Square shade	2215	2110
Square shade high	2363	2258

Box dimensions

The Kosmos shade comes in 1 box

Box 1: Kosmos shade + Cover

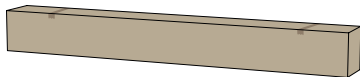

Box dimensions (mm)		L	W	H	Qty	Volume (m3)	Gross weight (kg)	Net weight (kg)	Packaging weight (kg)
Kosmos round shade	Box 1	2250	250	250	1	0,14	27,61	24,33	3,28
Kosmos round shade high	Box 1	2250	250	250	1	0,14	30,61	27,33	3,28
Kosmos square shade	Box 1	2675	260	290	1	0,20	29,85	26,57	3,28
Kosmos square shade high	Box 1	2675	260	290	1	0,20	32,85	29,57	3,28

Floor fastening

The floor fastening (parasol base) is available one dimension

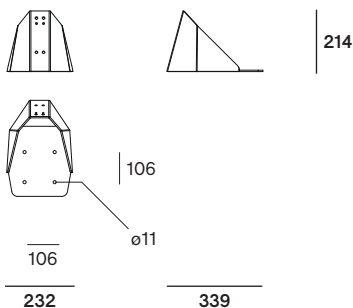

Box dimensions

The floor fastening (parasol base) comes in 1 box

Box 2: Floor fastening (parasol base)



Box dimensions (mm)		L	W	H	Qty	Volume (m3)	Gross weight (kg)	Net weight (kg)	Packaging weight (kg)
Floor fastening	Box 2	320	230	270	1	0,02	5,40	5,20	0,20

Concrete base

The concrete base is available in one dimension

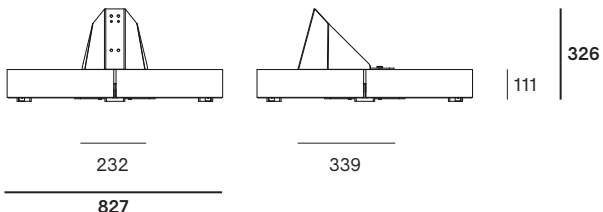
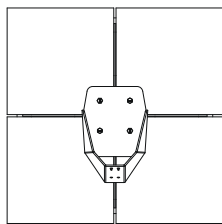

Box dimensions (mm)		L	W	H	Qty	Volume (m ³)	Gross weight (kg)	Net weight (kg)	Packaging weight (kg)
Concrete base	Box 2	320	230	270	1	0,02	5,40	5,20	0,20
	Box 3	376	376	100	4	0,06	120,00	114,00	6,00
	Box 4	720	310	130	1	0,03	7,20	6,50	0,70
Total:						0,11	132,60	125,7	6,90

Box dimensions

The concrete base comes in 6 boxes

Box 2: Floor fastening (parasol base)



Box 3: Concrete block



Box 4: Frame for concrete blocks



Concrete wheel base

The concrete wheel base is available in one dimension

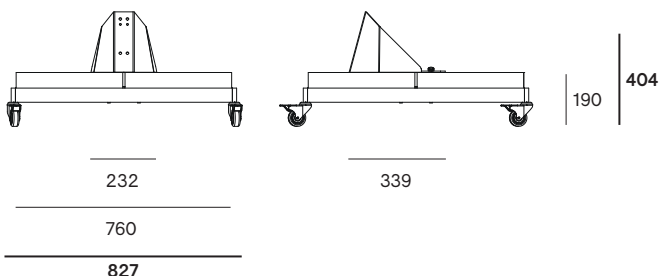
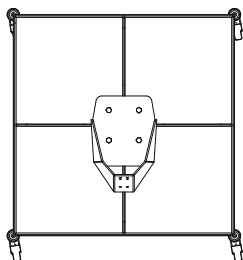

Box dimensions

The concrete wheel base comes in 6 boxes

Box 2: Floor fastening (parasol base)



Box 3: Concrete block



Box 5: Frame for concrete wheel base



Box dimensions (mm)		L	W	H	Qty	Volume (m ³)	Gross weight (kg)	Net weight (kg)	Packaging weight (kg)
Concrete wheel base	Box 2	320	230	270	1	0,02	5,40	5,20	0,20
	Box 3	376	376	100	4	0,06	120,00	114,00	6,00
	Box 5	850	850	150	1	0,11	22,40	21,00	1,40
Total:						0,19	147,80	119,41	7,60

Materials & colors

Check price list or www.extremis.com for current materials & colors

Fabric round shade



Black
High-tech polyester



Taupe
High-tech polyester

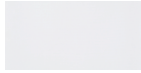

White
High-tech polyester

Fabric square shade

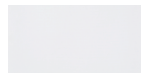

White
High-tech polyester

Pole



Stainless steel

Base frames



Galvanized steel



Materials	Key facts	Thickness mm	Layer thickness micron	Density	In/outdoor	Water	UV color fastness	Flame retarding
High-tech polyester fabric	<ul style="list-style-type: none"> High UV resistance and ultra strong Low weight / high tear strength Long-term appearance 	0,37	n.a.	250 g/m ³	Outdoor & indoor	The fabric has a water column of 350 mm (EN 20811)	7/8 (ISO 105-B02)	/
Stainless steel parasol base	<ul style="list-style-type: none"> High rust resistance Periodical maintenance required 	2 - 5	n.a.	8,00 10 ³ kg/m ³	Outdoor & indoor	n.a.	Very good	NEN-EN13501-1 A1 *
Hot dip galvanized steel base for concrete (wheel) base	<ul style="list-style-type: none"> Most durable method for protecting metal from rusting Protective layer Very long life span 100% recyclable Cradle to Cradle Certified™ 	2 - 10	50 - 100	7,50 10 ³ kg/m ³	Outdoor & indoor	n.a.	Very good, galvanization will however become less shiny when used outdoors	NEN-EN13501-1 A1 *
LED light with dimmer	<ul style="list-style-type: none"> Color temperature of 3000K (warm white) 350mA 7W 110 - 220 V 50 - 60 Hz 	n.a.	n.a.	n.a.	Outdoor & indoor	IP65	/	/
Cover	<ul style="list-style-type: none"> 100% polyester Polyuréthane coating Breathable, so not 100% waterproof 	0,50	n.a.	250 g/m ²	Outdoor & indoor	Water repellent & breathable	6-8/8 (ISO 105-B02)	/

NEN-EN13501-1 A1

Class A1 products will not contribute to fire in any stage, including fully developed fire. For this reason, they are assumed to be capable of satisfying all requirements of all lower classes as well.

Good to know

- The parasol cover is included.
- You can open and close the parasol like a fan. The shade stays open by means of magnets.
- After a long time not being in use, it's possible that the magnets loose strength.
- We advise the close the shade and apply the included cover.



Maintenance

PARASOL FABRIC

- Shake or brush off loose dirt immediately.
- Spray Extremis Multi Cleaner.
- Use a soft brush and make circular movements.
- Let the suds soak in for a moment.
- Rinse thoroughly to remove all soap residue.
- Simply allow to dry.

STAINLESS STEEL

- Clean regularly with a dry cloth and some stainless steel cleaner.

F.A.Q.

Q: How wind resistant is the shade?

A: Tests in a windtunnel have shown that the shade withstands wind speeds up to 6 on the Beaufort scale (49 km/h) when anchored to the floor. Still, we strongly advise to close it sooner (from 4 on the Beaufort scale is the rule of thumb (28 km/h)).

Q: Is the fabric 100% waterproof?

A: With light rain you stay easily seated underneath the shade. The fabric is slightly slanted in opened position. With heavy rain, the canvas lets through only a little bit of water. This is typical for the fabric and necessary, because the fabric should be able the ventilate.

Q: How long is the connection cable of the LED-light?

A: The connection cable itself has a length of 10 meters, without a plug. There is no plug so that the cable can run inside the parasol pole for installation. After the cable has been installed in the pole, roughly 8 meters of the cable is exposed and usable.

Q: Do you need to use a parasol cover?

A: The cover is needed to protect and fix the parasol when not in use. Protect your parasol from polluted rain, bird droppings, dust and heavy winds to avoid marks or stains on the parasol fabric.

Warnings

General

- Do not use any sharp tools to open the packaging.
- We strongly advise against using power tools.
- Tripping hazard, mind your step.
- Do not put out cigarettes on the parasol.
- Not graffiti proof.
- To avoid danger of suffocation, keep plastic bags away from babies and children.
- Colors can differ over years and from batch to batch.

Product

- Anchoring the product has to be done by qualified people.
- For anchoring: use suitable bolts or screws from a specialized store depending on the material your terrace is made of.
- Store the parasol when not used for a long time as follows: vertically, completely dry and in a dry environment.

- Do not leave closed if not completely dry. Do not leave the parasol closed for a long time when the parasol fabric is still damp or wet.
- In case of strong winds, close the parasol and use the slip-cover to prevent the parasol from opening or getting dirty.
- Do not leave the parasol unattended when opened.
- Tests in a windtunnel have shown that the shade withstands wind speeds up to 31 mph when anchored to the floor. Still, we strongly advise to close it sooner (from wind speed 18 mph).

High-tech polyester

- Shake or brush off loose dirt immediately.
- Do not use any aggressive detergents as they will remove the protective coating of the fabric.
- We strongly advise you not to use a high-pressure hose for cleaning.

Stainless steel

- Very good UV color fastness.
- Flame retarding: NEN-EN13501-1 A1 - Class A1 products will not contribute to fire in any stage, including fully developed fire. For this reason, they are assumed to be capable of satisfying all requirements of all lower classes as well.
- Watch out, stainless steel isn't entirely rustproof! Be sure to avoid contact with iron objects. If it does show signs of rust, clean with rust remover as quickly as possible.

Concrete

- Matt and porous.
- Very good UV colour fastness.
- Flame retarding: NEN-EN13501-1 A1 - Class A1 products will not contribute to fire in any stage, including fully developed fire. For this reason, they are assumed to be capable of satisfying all requirements of all lower classes as well.