

Gargantua

© design by Dirk Wynants

extremis®

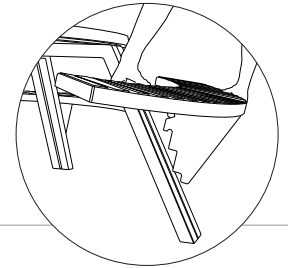

Dimensions

The Gargantua is available in one dimension

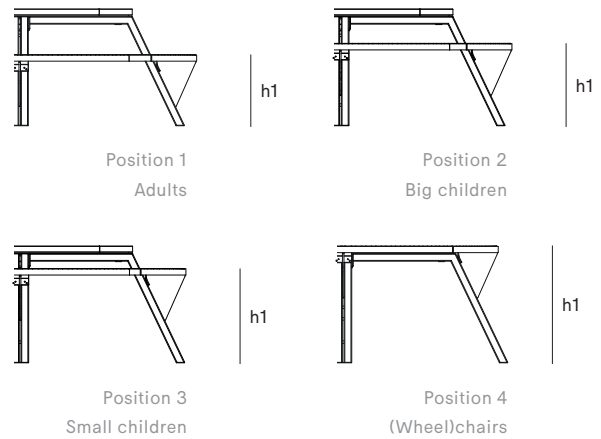
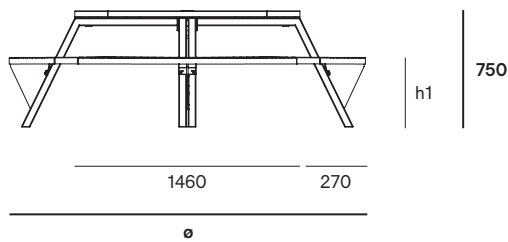
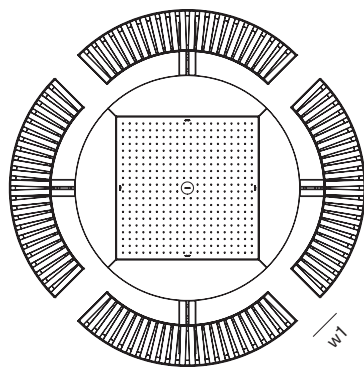

Dimensions (mm)	ø	h1	w1
Position 1	2309	450	209
Position 2	2235	524	157
Position 3	2161	599	105
Position 4	2014	751	1

Box dimensions

The Gargantua comes in 4 boxes

Box 1: Tabletop

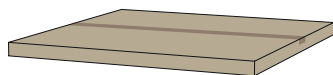

Box 2: benches



Box 3: Legs

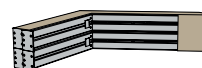

Box 4: Bench supports + mounting kit



Box dimensions (mm)		L	W	H	Qty	Volume (m3)	Gross weight (kg)	Net weight (kg)	Packaging weight (kg)
Gargantua	Box 1	1530	1500	80	1	0,18	50,40	44,20	6,20
	Box 2	1450	530	100	1	0,15	54,40	51,20	3,20
	Box 3	1850	240	110	1	0,05	39,60	36,80	2,80
	Box 4	330	275	255	1	0,02	21,00	18,40	2,60
Total:						0,40	165,40	150,60	14,80

Backrest

The backrest is available in one dimension

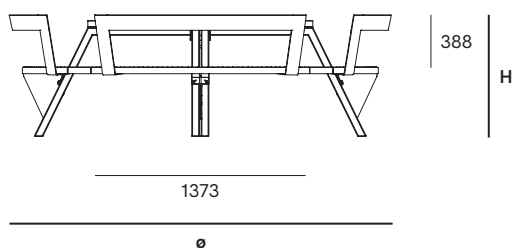
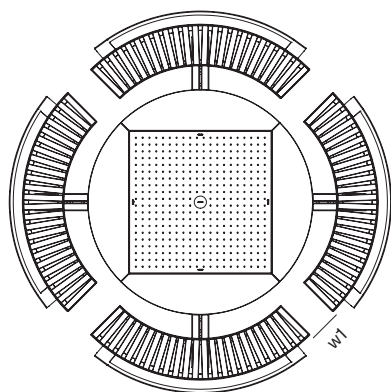

Backrest box

The backrests comes in 1 box

Box 5: Backrest (2x)

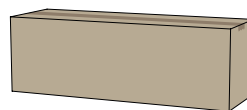

Dimensions (mm)	ø	H
Position 1	2480	787
Position 2	2406	861
Position 3	2332	942

Box dimensions (mm)		L	W	H	Qty	Volume (m ³)	Gross weight (kg)	Net weight (kg)	Packaging weight (kg)
Backrest (2pcs per box)	Box 5	1420	470	470	1	0,31	24,00	20,00	4,00

Cushions

The cushions is available in one dimension

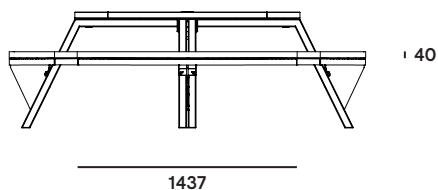
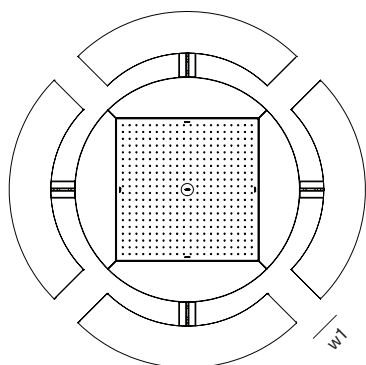

Cushions box

The cushions comes in 1 box

Box 6: Cushions (4x)



Box dimensions (mm)		L	W	H	Qty	Volume (m ³)	Gross weight (kg)	Net weight (kg)	Packaging weight (kg)
Cushions (4pcs per box)	Box 6	1430	480	230	1	0,16	7,20	4,80	2,40

Floor fastening

The floor fastening is available in one dimension

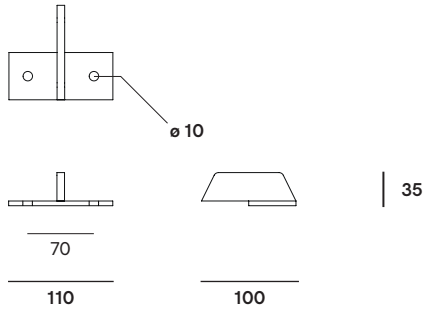

Floor fastening box

The floor fastening comes in 1 box

[Box 7: Floor fastening](#)



Box dimensions (mm)		L	W	H	Qty	Volume (m ³)	Gross weight (kg)	Net weight (kg)	Packaging weight (kg)
Floor fastening	Box 7	200	140	140	1	0,01	1,29	1,19	0,10

Bench fastening

The bench fastening is available in one dimension

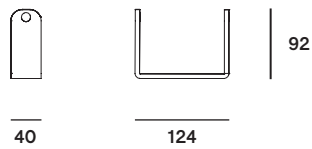

Bench fastening box

The bench fastening comes in 1 box

[Box 8: Bench fastening](#)



Box dimensions (mm)		L	W	H	Qty	Volume (m ³)	Gross weight (kg)	Net weight (kg)	Packaging weight (kg)
Bench fastening	Box 8	200	140	140	1	0,01	1,29	1,19	0,10

Wheelchair accessibility dimensions

Gargantua is wheelchair accessible

Put two benches at tabletop height (there are no obstacles underneath the tabletop)

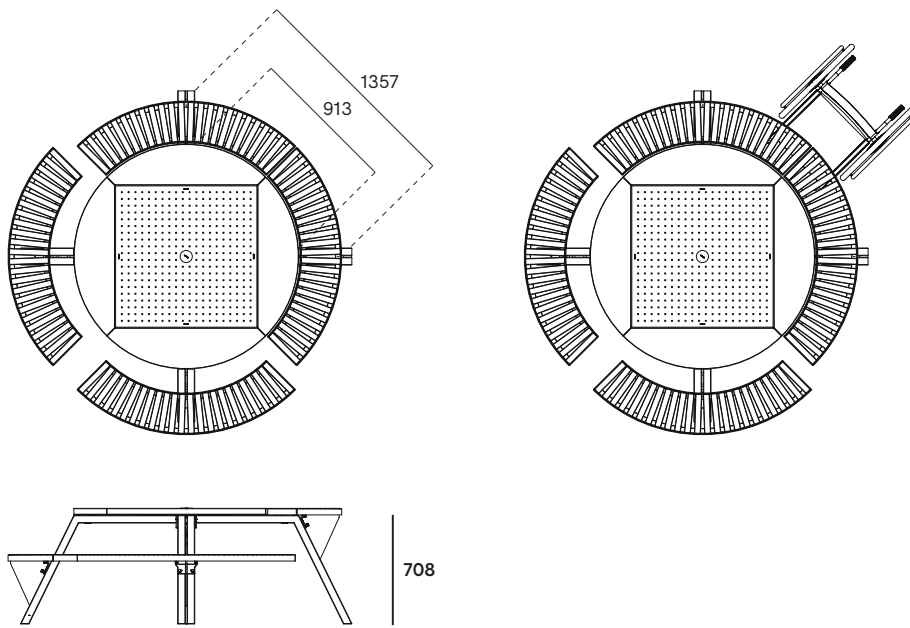

Materials & colors

Check price list or www.extremis.com for current materials & colors

Tabletop & benches

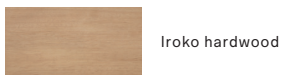

Sunbrella® cushions

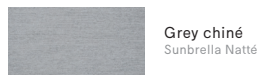

Frame, legs & backrest

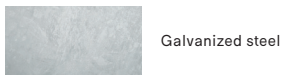

Tabletop centreplate

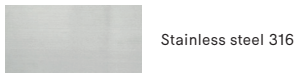

Materials	Key facts	Thickness	Layer thickness	Density	In/outdoor	Water	UV color fastness	Flame retarding
		mm	micron					
Iroko tabletop & benches	<ul style="list-style-type: none"> Durability CLASS 1 Feels comfortable in all weather conditions Advisable to oil the wood 	20 benches 40 tabletop	n.a.	600 à 700 kg/m ³	Outdoor & indoor	n.a.	Untreated wood turns grey after a while	/
Iroko tabletop & benches	 <ul style="list-style-type: none"> Durability CLASS 1 Carries the FSC® label for durable forestry Feels comfortable in all weather conditions Advisable to oil the wood 	20 benches 40 tabletop	n.a.	600 à 700 kg/m ³	Outdoor & indoor	n.a.	Untreated wood turns grey after a while	/
Hot dip galvanized steel frame, legs & backrest	<ul style="list-style-type: none"> Most durable method for protecting metal from rusting Protective layer Very long life span 100% recyclable Cradle to Cradle Certified™ 	2 - 10	50 - 100	7,50 10 ³ kg/m ³	Outdoor & indoor	n.a.	Very good, galvanization will however become less shiny when used outdoors	NEN-EN13501-1 A1 *
Stainless steel tabletop centreplate AISI 316	<ul style="list-style-type: none"> High rust resistance Periodical maintenance required 	2	n.a.	8,00 10 ³ kg/m ³	Outdoor & indoor	n.a.	Very good	NEN-EN13501-1 A1 *
Sunbrella® cushions	<ul style="list-style-type: none"> 100% Sunbrella Acrylic Best outdoor fabric available for making cushions Dirt repellent Not waterproof, store inside! Machine washable at max. 30°C. Ironing restores the protective layer 	0,50	n.a.	260 g/m ²	Outdoor & indoor	The fabric has a water column of 350 mm (EN 20811)	7/8 (ISO 105-B02)	/

NEN-EN13501-1 A1 Class A1 products will not contribute to fire in any stage, including fully developed fire. For this reason, they are assumed to be capable of satisfying all requirements of all lower classes as well.

Good to know

- The hole in the tabletop to place a parasol in is $\varnothing 65$ mm.
- Gargantua combines perfectly with Inumbra medium/large & Inumbra large. For both combinations, a connection piece is required.



F.A.Q.

Q: Do you need to oil the wood?

A: Just like other types of wood, wood will gradually become rougher and start to turn grey as a consequence of exposure to the sun and rain. Small cracks and crevices can also appear as part of this process. We strongly advise everyone to treat the furniture with our Wood Protector. This 100% natural oil controls the moisture level within the wood, which makes the planks stay stable for longer, and the layer of oil also helps to prevent spilled liquids from being absorbed, so that stains tend to stay superficial. It is best to repeat this treatment at regular intervals.

Q: All benches on the highest level = a table for 12 people?

A: Yes, but this position is not meant to be used all the time.

Floor fastening

Gargantua has an optional floor fastening set, four galvanized steel plates to be fixed with bolts.



Maintenance

GALVANIZED PARTS

- Clean with lukewarm water and a mild detergent or Extremis multi cleaner.

WOOD

- Clean regularly with mild detergent.
- Thorough cleaning with Extremis Wood Cleaner.
- Oil the wood with Extremis Wood Protector. We recommend oiling the wood at regular intervals depending from location and general weather conditions.
- In order to smoothen the surface again after a thorough cleaning, lightly sand your wood with 80 grit sanding paper or a sanding pad.

STAINLESS STEEL

- Clean regularly with a dry cloth and some stainless steel cleaner

SUNBRELLA

- Shake or brush off loose dirt immediately.
- Spray Extremis Multi Cleaner.
- Use a soft brush and make circular movements.
- Let the suds soak in for a moment.
- Rinse thoroughly to remove all soap residue.
- Simply allow to dry.
- It's also possible to put the blanket and the pillow covers in a washing machine (max 40°C). Follow the cleaning instruction on the label.
- If the cushion has metal brackets, we recommend turning the cover inside out first to avoid damaging the washing machine. In this case, leave the zipper open about 10 cm.

RECOMMENDED USE

- For Extremis Wood protector:

		
7 to 10 wood care treatments	3 to 5 wood care treatments	100 - 150 ml for one Gargantua

Bench fastening

For public spaces, Gargantua comes with an optional bench fastening set: four galvanized steel brackets to be fixed to the legs.

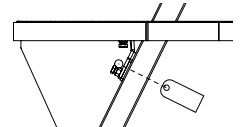

Warnings

General

- Do not use any sharp tools to open the packaging.
- We strongly advise against using power tools.
- Tripping hazard, mind your step.
- Do not put out cigarettes on the table.
- Not graffiti proof.
- Do not leave children unattended whilst playing on the table.
- To avoid danger of suffocation, keep plastic bags away from babies and children.
- Colors can differ over years and from batch to batch.

Product

- Do not stand or jump on the table.
- Do not drag the table, but carry it with minimum 2 people.
- Anchoring the product has to be done by qualified people.
- For anchoring: use suitable bolts or screws from a specialized store depending on the material your terrace is made of.
- To change the height of the bench, grab the bench with both hands on the frame and do not pull on the wood.
- Make sure the bench is securely fixed and is hanging in a horizontal position.
- The slight movement you feel when sitting down is the result of the space we need to hook or unhook the benches. If this would be too narrow, moving the benches would no longer be possible.
- Gargantua is not designed to keep the benches at the highest level at all time. We recommend to

only place the benches at the tabletop level for exceptional situations. The benches and tabletop do not form an even surface; level deviations up to 1 cm may appear.

- The centreplate of the tabletop reflects in the sunlight.
- Max. 3 people or 240 kg per bench.

Wood

- When delivered, the wood is untreated.
- Wood is a natural material and its look is different for every slat, plank and tree.
- Wood will gradually become rougher and start to turn grey as a consequence of exposure to the sun and rain. We recommend oiling the wood at regular intervals depending from location and general weather conditions.
- Clean regularly with mild detergent. Never use a high pressure cleaner as this will roughen the wood's smooth surface and irreparably damage the wood's fiber.
- Thorough cleaning with Extremis Wood Cleaner.
- We strongly recommend that you treat your wood with wood protector to protect it from stains - small cracks and crevices can also appear as part of this process. We strongly advise everyone to treat the furniture with our Wood Protector.

Galvanized steel

- Galvanization will become less shiny when used outdoors.
- Flame retarding - NEN-EN13501-1 A1 - Class A1

products will not contribute to fire in any stage, including fully developed fire. For this reason, they are assumed to be capable of satisfying all requirements of all lower classes as well.

- Possible impurities in the immersion tank can cause black marks during galvanization, which are intrinsic to this industrial finishing technique.
- White marks on this zinc layer are also intrinsic to this procedure and will disappear when the furniture is put outdoors.
- This industrial finishing technique may result in a rougher surface. This is intrinsic to the process.

Stainless steel

- Very good UV color fastness.
- Flame retarding: NEN-EN13501-1 A1 - Class A1 products will not contribute to fire in any stage, including fully developed fire. For this reason, they are assumed to be capable of satisfying all requirements of all lower classes as well.
- Watch out, stainless steel isn't entirely rustproof! Be sure to avoid contact with iron objects. If it does show signs of rust, clean with rust remover as quickly as possible.

Sunbrella

- Not waterproof, store inside!
- Shake or brush off loose dirt immediately.
- UV color fastness: 7/8 (ISO 105-B02).